

HK3518-RS

Drawn cup needle roller bearing open end

Schaeffler ID:
0007909230968

Drawn cup needle roller bearings with open ends HK..-RS, lip seal on one side, to DIN 618

Technical information

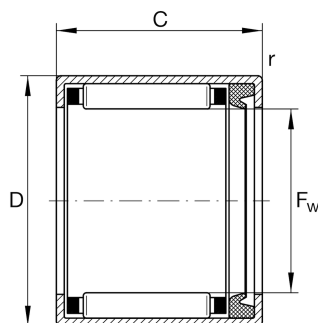

Main Dimensions & Performance Data

F_w	35 mm	Under roller diameter
D	42 mm	Outside diameter
C	18 mm	Width
C_r	18,700 N	Basic dynamic load rating, radial
C_{0r}	33,500 N	Basic static load rating, radial
C_{ur}	4,450 N	Fatigue load limit, radial
n_G	4,500 1/min	Limiting speed
$n_{G \text{ Grease}}$	4,500 1/min	Limiting speed for grease lubrication
	38.62 g	Weight

Dimensions

C_1	18 mm	Width, outer ring
r_{\min}	0.8 mm	Minimum chamfer dimension
	LR30X35X20,5	Suitable inner rings LR
	IR30X35X20-XL	Suitable inner rings IR

Temperature range

T_{\min}	-20 °C	Operating temperature min.
T_{\max}	100 °C	Operating temperature max.